

Connectors and Accessories Selection Guide

D38999 Series III

For Military, Aerospace & Harsh Environments



WE'RE MATING TECHNOLOGY WITH CONFIDENCE



www.matecelectronics.com

Table of Content

- 01** - Table of Content
- 02** - About Our Company
- 03** - How We Serve
- 04** - Inventory Solutions
- 05** - Electrical and Mechanical Characteristics
- 07** - MIL-DTL-38999 Series III, How to Order Military Designation
- 08** - MIL-DTL-38999 Series III, How to Order Amphenol Designation
- 09** - Square Flange Receptacle & Jam-Nut Receptacle
- 10** - Straight Plug
- 11** - Panel Drilling for Receptacles
- 12** - Insert Arrangements
- 16** - BK4S Backshell Drawing
- 17** - Boots
- 18** - Dust Caps
- 19** - Gaskets
- 21** - Contacts
- 22** - Application Tools
- 23** - Other Backshells

About MATEC

MATEC Electronics is an authorized and leading distributor, that specializes on the design and custom-engineered connectors, cables and electronic interconnect solutions for Military-Aerospace, Industrial and Telecom market fields. MATEC's deep technical and commercial knowledge on it's concentrated product portfolio has made the company the chosen distributor of the customers in the region it serves, Turkey, Middle East, Africa and Eastern Europe. Headquartered in Istanbul, MATEC also has a branch office in Ankara and warehouses in Istanbul and NY, U.S.A. With it's highly experienced team, knowledge on dynamic supply chain solutions and rich inventory, MATEC has provided it's customer with the best technical and commercial service along with the quality products since it was founded in 2011. Our first priority is complete customer satisfaction. While MATEC's IPC/WHMA-A-620 certified technical team acts as design partner in your projects, the company commercial team ensures that the service given has it is highest achievable standards. Due to the fact that MATEC Electronics works with the world's well-known companies, it offers its products with proven quality to its customers. We are ISO 9001:2015 registered and dedicated to use those guidelines for your satisfaction.

Contact Us

Head Office

Ahi Evran Cad. No:21
Kat: 4 Daire: 24
Polaris Plaza Maslak,
Sariyer, ISTANBUL

Phone: +90 212 346 16 06

Branch Office

Prof. Dr. Ahmet
Taner Kışlalı Mah.
2879. Sok. No:14
Cankaya, Ankara

Phone: +90 312 240 04 14



How We Serve

As a leading and authorized distributor, MATEC Electronics supports all types electrical interconnect requirements of Mil-Aero projects. MATEC is not only able to provide solutions to electronic interconnect requirements technically, but it also provides best commercial experience to its customers with dynamic team.

5015 Series Connectors



Backshells



26482 Series Connectors

Inventory Solutions

In addition to commercial and customized harsh environment Mil-Aero series, MATEC also offers most popular qualified Mil-Spec versions for all type of your projects from it's inventory. MATEC also supports all type of connector accessory requirements like strain reliefs, backshells, heat shrink tubes and contacts, providing order-to-manufacture kit solutions.

D38999 Series Connectors



Boots



2M Series Connectors



MIL-DTL-38999 Series III

Amphenol® Tri-Start MIL-DTL-38999 Series III Connectors offer the highest performance capabilities for both general duty and severe environment applications. Meeting or exceeding MIL- DTL-38999 Series III requirements, the Tri-Start connector with standard metal shells (aluminum or stainless steel with several finish options) offers these features:

EMI Shielding: EMI shielding capability of 65dB minimum at 10 GH

Moisture Resistance: Improved Interfacial Seal

Quick Coupling: Completely mates and self-locks in a 360° turn of the coupling nut

Mating Cycle: 500 couplings minimum

Thermoplastic insert

Silicone rubber back insert and interfacial seal

Contact Size	Test Current (Amps)		Maximum Millivolt Drop Crimp*	Maximum Millivolt Drop Hermetic*	Contact Resistance	Contact Retention Force
	Crimp	Hermetic				
23	5	3	73	85	15	44
22M	3	2	45	60	8	44
22D	5	3	73	85	8	44
22	5	3	73	85	4.7	67
20	7.5	5	55	60	2	111
16	13	10	49	85	1.1	111
12	23	17	42	85	0.8	111
10 (Power)	33	NA	33	NA	0.8	111
8 (Power)	46	NA	26	NA	0.6	111
4	80	NA	23	NA	0.26	150
0	150	NA	21	NA	-	-

Service Rating	Suggested Oper. Voltage (Sea Level)		Test Voltage (Sea Level)	Test Voltage (50,000 ft)	Test Voltage (70,000 ft)	Test Voltage (110,000 ft)
	AC (RMS)	DC				
N	400	500	1300 VRMS	550 VRMS	350 VRMS	200 VRMS
M	300	450	1000 VRMS	400 VRMS	260 VRMS	200 VRMS
I	600	850	1800 VRMS	600 VRMS	400 VRMS	200 VRMS
II	900	1250	2300 VRMS	800 VRMS	500 VRMS	200 VRMS

Applications: Military / Aerospace



MIL-DTL-38999 Series III

Shell Material	Shell Finish	Salt Spray Exposure per EIA364.26	Class Norm	Amphenol	Operating Temperature		Shell to Shell Conductivity
					Min	Max	
Composite	Electroless Nickel	2000 H	M	CTV-RF	-65°C	+200°C	3mΩ
	O.D Cadmium	2000 H	J	CTV-RW	-65°C	+175°C	3mΩ
Aluminium	Electroless Nickel	48 H	F	TVS-RF	-65°C	+200°C	1mΩ
	O.D Cadmium	500 H	W	TV-RW	-65°C	+175°C	2.5mΩ
	Durmalon (Ni-PTFE)	500 H	T	TV-DT	-65°C	+175°C	2.5mΩ
	Green Zinc Cobalt	96 H	-	TV-RZ	-65°C	+175°C	3mΩ
	Black Zinc Nickel	500 H	Z	TV-ZN TV-DZ	-65°C	+175°C	2.5mΩ
Stainless Steel	Nickel	500 H	S	TVS-RS	-65°C	+200°C	1mΩ
	-	500 H	K	TVS-RK	-65°C	+200°C	10mΩ
Bronze	-	500 H		TVS-RB	-65°C	+200°C	5mΩ

Contact Size	Contact Diameter (mm)	Crimp Barrel		Acceptable Cables						
		Diameter (mm)	Depth (mm)	Gauge AWG Section (mm ²)				Outside Diameter (mm)		
				22	24	26	28	Min	Average	Max
23	0.68	0.88±0.03	3.81	22	24	26	28	-	-	1.2
				0.38	0.22	0.15	0.095			
22D	0.76	0.88±0.03	3.58	22	24	26	28	0.76	1.20	1.37
				0.38	0.22	0.15	0.095			
20	1	1.19±0.03	5.30	20	22	24	-	1.02	1.83	2.11
				0.60	0.38	0.22	-			
16	1.57	1.70±0.03	5.30	16	18	20	-	1.68	2.41	2.77
				1.34	0.93	0.60	-			
12	2.36	2.54±0.03	10.00	12	14	-	-	2.46	3.20	3.61
				3.30	1.94	-	-			
8	3.60	4.60±0.03	10.00	8				4.50	-	5.20
				8.98 Max Acceptable: 10mm ²						
4	5.70	7.40±0.03	12.00	4				7.73	-	8.40
				21.10						

MIL-DTL-38999 Series III

How to Order

MILITARY DESIGNATION

D38999/ 26 W B35 P N - BK4S - B1-DC -CG

Series: _____

Shell Type: _____

20: Square Flange Receptacle 24: Jam-Nut Receptacle
26: Straight Plug

Shell Material and Finish: _____

Composite:

J: Olive drab cadmium plated 175°C M: Electroless nickel plated 200°C

Aluminium:

W: Olive drab cadmium plated 175°C
F: Electroless nickel plated 200°C
T: Nickel PTFE plated 175°C
Z: Black Zinc Nickel plated aluminium 175°C

Stainless Steel:

K: Passivated 200°C, firewall capability
S: Nickel plated 200°C, firewall capability

Shell Size and Contact Arrangement: _____

Shell Size:

A B C D E F G H J MIL
09 11 13 15 17 19 21 23 25 Amphenol

Contact Arrangement:

See section "Insert Arrangements"

Contact Type: _____

A: Without pin contact
B: Without socket contact
P: With pin contacts
S: With socket contacts

Polarization: _____

N for normal or A, B, C, D, E.

Backshell Type: _____

BK4S: Straight Direct Coupling EMI Backshell with Constant Force Spring and Conductive Tape
BK4R: 90 Degree Spin Coupling EMI Backshell with Band for Braid Fixing (Please consult us for cable entry)
*Omit for no backshell

Boot Type: _____

B1: Straight Boot
B2: 90 Degree Boot
*Omit for no boot

Dust Cap: _____

Metallic Dust Cap
*Omit for no cap

Conductive Gasket: _____

Conductive Gasket
*Omit for no gasket

MIL-DTL-38999 Series III

How to Order

AMPHENOL DESIGNATION

TV 06 R W 11-35 P A - BK4S B2 DC CG

Series: _____

Shell Type: _____

- P00: Square flange receptacle: 175°C (0 .D. cadmium, g. zinc cobalt, ni-PTFE, b. zinc nickel)
- PS00: Square flange receptacle: 200°C *** (nickel, s. steel, bronze)
- 07: Jam nut receptacle: 175°C (0. D. cadmium, g. zinc cobalt, ni-PTFE, b. zinc nickel)
- S07: Jam nut receptacle: 200°C *** (nickel, s. steel, bronze)
- 06: Straight plug: 175°C (0. D. cadmium, g. zinc cobalt, ni-PTFE, b. zinc nickel)
- S06: Straight plug: 200°C *** (nickel, s. steel, bronze)
- 01: In line receptacle: 175°C (0. D. cadmium, g. zinc cobalt, ni-PTFE, b. zinc nickel)
- S01: In line receptacle: 200°C *** (nickel, s. steel, bronze)

Contact Type: _____

- R: Crimp contacts (or connector delivered without contact)
- *For pc tail contacts directly get in touch with MATEC Electronics

Class: _____

- W: Olive Drab Cadmium plating (on aluminium or composite)
- F: Nickel Plating (on aluminium or composite)
- K: Passivated Stainless Steel
- S: Nickel plated Stainless Steel
- B: Marine Bronze (copper aluminium alloy)
- Z: Green zinc Cobalt plated aluminium
- ZN: Black Zinc Nickel plated aluminium

Shell Size and Contact Arrangement: _____

*** See section "Insert Arrangements"

Contact type: _____

- A: Without pin contact
- B: Without socket contact
- P: With pin contacts
- S: With socket contacts

Polarization: _____

N for normal or A, B, C, D, E.

Contacts: _____

- Omit for connectors delivered with contacts
- LC: Connector delivered without contacts

Backshell Type: _____

- BK4S: Straight Direct Coupling EMI Backshell with Contact Force Spring and Conductive Tape
- BK4R: 90 Degree Spin Coupling EMI Backshell with Band for Braid Fixing (Please consult us for cable entry)

*Omit for no backshell

Boot Type: _____

- B1: Straight Boot
- B2: 90 Degree Boot

*Omit for no boot

Dust Cap: _____

- Metallic Dust Cap **Omit for no cap*

Conductive Gasket: _____

- Conductive Gasket **Omit for no gasket*

MIL-DTL-38999 Series III

Square Flange Receptacle

MIL DESIGNATION: D38999/20

AMPHENOL DESIGNATION: TVP00, TVPS00

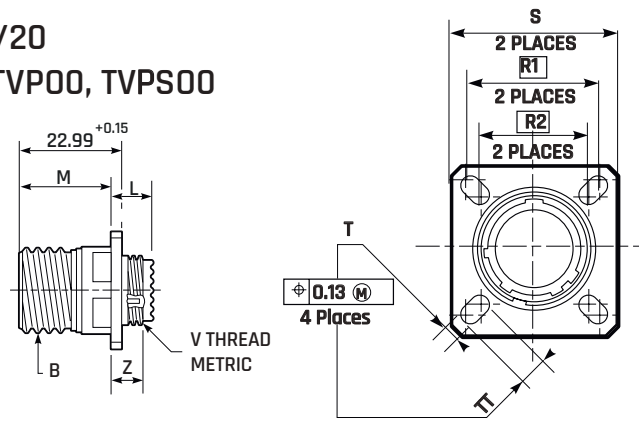

Shell Size		B Thread Class 2A 0.1P - 0.3L- TS (Inches)	L Max (mm)	M +0.00 -0.13 (mm)	R1 (mm)	R2 (mm)	S ±0.25 (mm)	T +0.20 -0.13 (mm)	Z1 Max (mm)	TT +0.20 -0.13 (mm)	V Thread Metric
MIL-DTL-38999 Series III	Amphenol										
A	9	.6250	11.91	20.83	18.26	15.09	23.83	3.25	3.89	5.49	M12x1-6g
B	11	.7500	11.91	20.83	20.62	18.26	26.19	3.25	3.89	4.93	M15x1-6g
C	13	.8750	11.91	20.83	23.01	20.62	28.58	3.25	3.89	4.93	M18x1-6g
D	15	1.0000	11.91	20.83	24.61	23.01	30.96	3.25	3.89	4.39	M22x1-6g
E	17	1.1875	11.91	20.83	26.97	24.61	33.32	3.25	3.89	4.93	M25x1-6g
F	19	1.2500	11.91	20.83	29.36	26.97	36.53	3.25	3.89	4.93	M28x1-6g
G	21	1.3750	12.70	20.07	31.75	29.36	39.67	3.25	4.65	4.93	M31x-1-6g
H	23	1.5000	12.70	20.07	34.93	31.75	42.88	3.91	4.65	6.15	M34x1-6g
J	25	1.6250	12.70	20.07	38.10	34.93	46.02	3.91	4.65	6.15	M37x1-6g

MIL-DTL-D38999 Series III

Jam-Nut Receptacle

MIL DESIGNATION: D38999/24

AMPHENOL DESIGNATION: TV07, TVS07

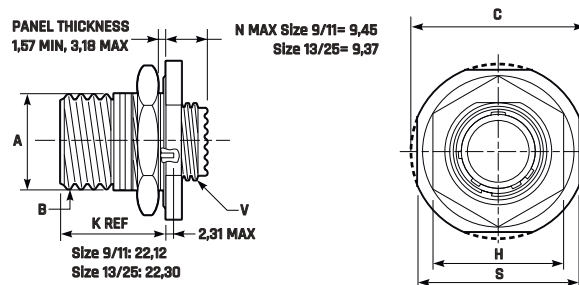

Shell Size		B Thread Class 2A 0.1P - 0.3L- TS (Inches)	A +0.10 0.15 (mm)	C Max (mm)	H Hex +0.43 -0.41 (mm)	S +/- 0.4 (mm)	V Thread Metric	Hex Nut Max Torque N.m
MIL-DTL-38999 Series III	Amphenol							
A	9	.6250	16.53	30.45	22.23	26.97	M12x1-6g	4.1
B	11	.7500	19.07	35.20	25.40	31.75	M15x1-6g	5.3
C	13	.8750	23.82	38.38	30.17	34.93	M18x1-6g	6.9
D	15	1.0000	26.97	41.55	33.32	38.10	M22x1-6g	8.6
E	17	1.1875	30.15	44.73	36.52	41.28	M25x1-6g	9.8
F	19	1.2500	33.32	49.50	39.67	46.02	M28x1-6g	10.9
G	21	1.3750	36.50	52.65	42.87	49.23	M31x1-6g	12.7
H	23	1.5000	39.67	55.85	46.02	52.37	M34x1-6g	13.8
J	25	1.6250	42.85	59.00	50.80	55.58	M37x1-6g	15

MIL-DTL-38999 Series III

Straight Plug

MIL DESIGNATION: D38999/26

AMPHENOL DESIGNATION: TV06 TVS06

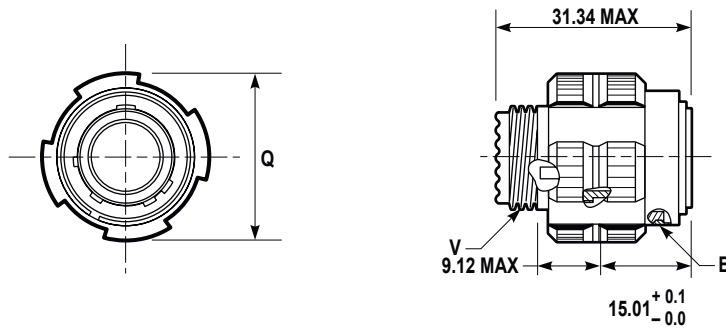

Shell Size		B Thread Class 2A 0.1P - 0.3L- TS	Q Max (mm)	V Thread Metric
MIL-DTL-38999 Series III	Amphenol			
A	9	.6250	21.82	M12x1-6g
B	11	.7500	24.62	M15x1-6g
C	13	.8750	28.98	M18x1-6g
D	15	1.0000	32.16	M22x1-6g
E	17	1.1875	35.33	M25x1-6g
F	19	1.2500	38.10	M28x1-6g
G	21	1.3750	41.28	M31x1-6g
H	23	1.5000	44.45	M34x1-6g
J	25	1.6250	47.63	M37x-1-6g

MIL-DTL-38999 Series III

Panel Drilling for Receptacles

Square flange receptacle
rear panel mounting

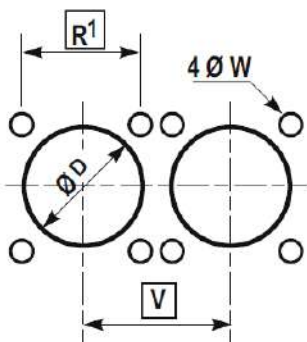

Square flange receptacle
front panel mounting

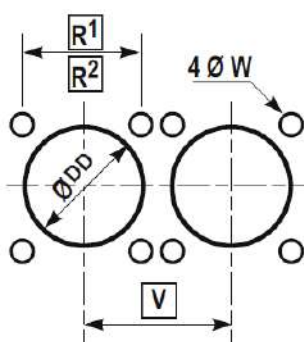

Jam nut receptacle
rear panel mounting

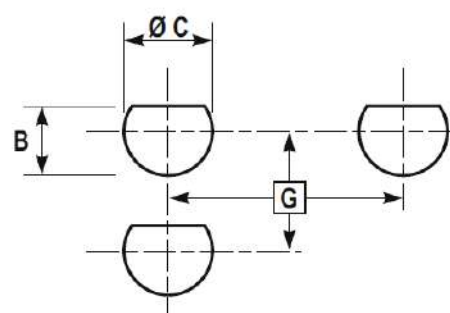























Shell Size	R ¹ (mm)	R ² (mm)	V mini (mm)	ØD Min (mm)	ØDD Min (mm)	ØW ±0.25 (mm)	G Mini (mm)	ØC ±0.25 (mm)	B ±0.25 (mm)
A=9	18.26	15.09	24.60	16.66	13.11	3.25	27.80	17.60	16.70
B=11	20.62	18.26	27.00	20.22	15.88	3.25	32.60	20.96	19.59
C=13	23.01	20.62	30.20	23.42	19.05	3.25	36.00	25.65	24.26
D=15	24.61	23.01	33.30	26.59	23.01	3.25	39.60	28.83	27.56
E=17	26.97	24.61	36.50	30.96	25.81	3.25	43.30	32.01	30.73
F=19	29.36	26.97	39.30	32.94	28.98	3.25	47.00	35.18	33.91
G=21	31.75	29.36	42.50	36.12	32.16	3.25	50.60	38.35	37.08
H=23	34.93	31.75	45.70	39.29	34.93	3.81	54.20	41.53	40.26
J=25	38.10	34.93	48.80	42.47	37.69	3.81	59.70	44.70	43.43









MIL-DTL-38999 Series III







Insert Arrangements







Front Face of Pin Inserts Shown

														
Insert Arrangement	9-5	9-9 HD	9-35	9-94	9-98	11-2	11-4	11-5	11-19 HD	11-35	11-54	11-98	11-99	13-4
Service Rating	Grounded	N	M	M	I	I	I	I	N	M	II	I	I	I
Number of Contacts	1	9	6	2	3	2	4	5	19	13	4	6	7	4
Contact Size	Twinax	23	22D	20	20	16	20	20	23	22D	22D	20	20	16

									
Insert Arrangement	13-8	13-26	13-32 HD	13-35	13-63	13-98	15-AT	15-4	15-5
Service Rating	I	M	N	M	I	I	I	I	II
Number of Contacts	8	6 2	32	22	2 2	10	10 3	4	5
Contact Size	20	22D 12	23	22D	16 12	20	22D 12	12	16

								
Insert Arrangement	15-15	15-18	15-19	15-25	15-35	15-55 HD	15-97	17-EA
Service Rating	I	I	I	M	M	N	I	
Number of Contacts	14 1	18	19	22 3	37	55	8 4	10 3 2 4
Contact Size	20 16	20	20	22D 16	22D	23	20 16	22D 20 16 12

							
Insert Arrangement	17-EC	17-2	17-6	17-8	17-22	17-26	17-35
Service Rating		M	I	I	Coax	I	M
Number of Contacts	32 9	38 1	6	8	2 2	26	55
Contact Size	22D 20	22D 8 Twinax	12	16	12 Coax 8 Coax	20	22D

						
Insert Arrangement	17-52	17-60	17-73 HD	17-99	19-FA	19-11
Service Rating	M	I/Coax	N	I	M	II
Number of Contacts	2	8 2	73	21 2	6 8 7 2	11
Contact Size	8 Twinax	22D 8 Coax	23	20 16	22D 20 16 12	16

MIL-DTL-38999 Series III

Insert Arrangements

Front Face of Pin Inserts Shown

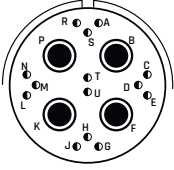
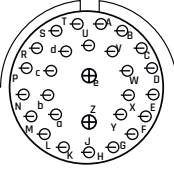
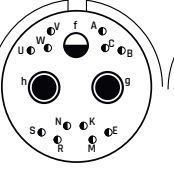
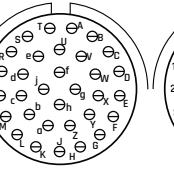
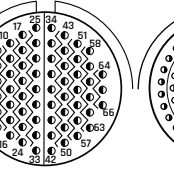
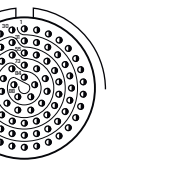
						
Insert Arrangement	19-18	19-28	19-31	19-32	19-35	19-88 HD
Service Rating	M	M	M	1	M	N
Number of Contacts	14 4	26 2	2 1 12	32	66	88
Contact Size	22D 8 Twinax	20 16	8 Coax 12 22D	20	22D	23

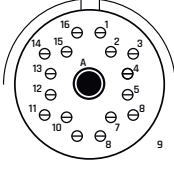
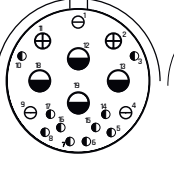
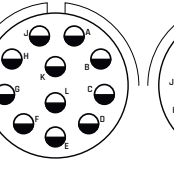
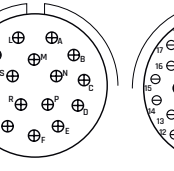
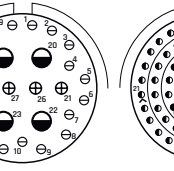
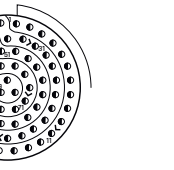
						
Insert Arrangement	19-AD	19-FA	21-11	21-16	21-29	21-35
Service Rating	Inst.	M	I	II	I	M
Number of Contacts	16 1	6 8 7 2	11	16	19 4 4	79
Contact Size	20 8 Twinax	22D 20 16 12	12	16	20 16 12	22D

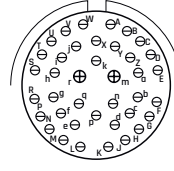
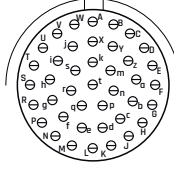
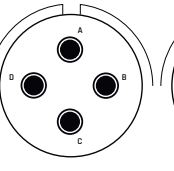
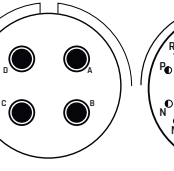
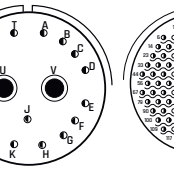
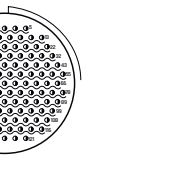
						
Insert Arrangement	21-39	21-41	21-48	21-75	21-79	21-121 HD
Service Rating	1	I	M	N	II	N
Number of Contacts	37 2	41	4	4	17(See Note)	121
Contact Size	20 16	20	8 Power	(See Note)	22D	23

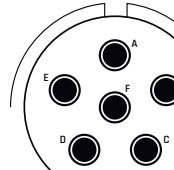
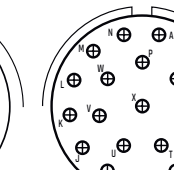
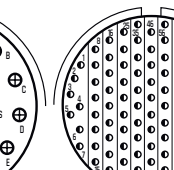
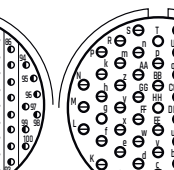
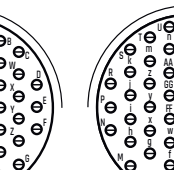
					
Insert Arrangement	23-6	23-21	23-35	23-53	23-55
Service Rating	M	II	M	I	I
Number of Contacts	6	21	100	53	55
Contact Size	8 Twinax	16	22D	20	20

Note: Military connectors 21-75 is supplied with 4 size 8 twinax contacts. Commercial connectors 21-75 is supplied with 4 size 8 coax contacts. Military connector 21-79 has provision for 2 size 8 coax contacts. Coax contacts are not supplied unless specified by customers.

MIL-DTL-38999 Series III

Insert Arrangements

Front face of pin inserts shown

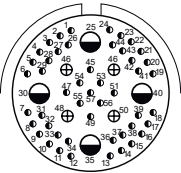
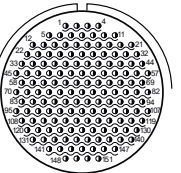
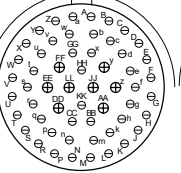
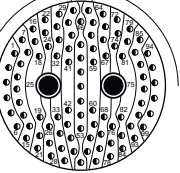
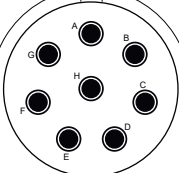
					
Insert Arrangement	23-63	23-151 HD	25-4	25-7	25-8
Service Rating	M	N	I	M	Twinax
Number of Contacts	49 4 4	151	48 8	97 2	8
Contact Size	22D 16 12	23	20 16	22D 8 Twinax	8 Twinax

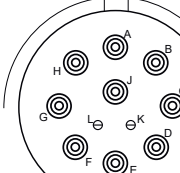
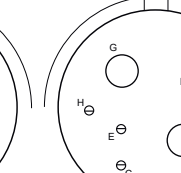
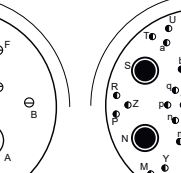
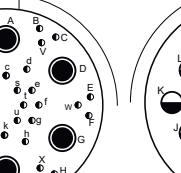
				
Insert Arrangement	25-11	25-16	25-17	25-19
Service Rating	N	M	M	I
Number of Contacts	2 9	6 2	36 6	19
Contact Size	20 10	20 4	22D 8 Twinax	12

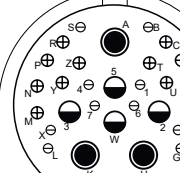
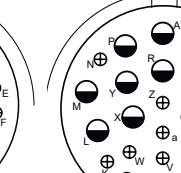
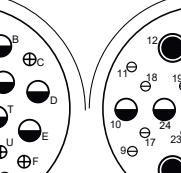
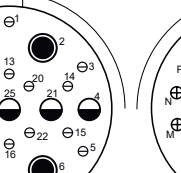
				
Insert Arrangement	25-20	25-24	25-26	25-29
Service Rating	N	I	I	I
Number of Contacts	10 13 3 4	12 12	16 5 4	29
Contact Size	20 16 8 Twinax 12 Coax	16 12	20 12 8 Coax	16

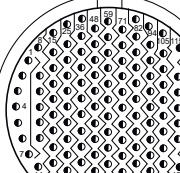
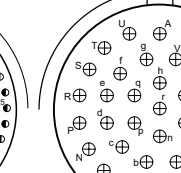
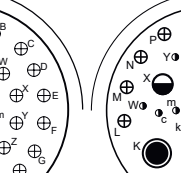
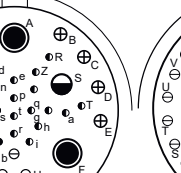
				
Insert Arrangement	25-35	25-37	25-41	25-43
Service Rating	M	I	N/Inst.	I
Number of Contacts	128	37	22 3 11 2 3	23 20
Contact Size	22D	16	22D 20 16 12 Coax 12 Twinax	20 16

MIL-DTL-38999 Series III

Insert Arrangements

Front Face of Pin Inserts Shown

Insert Arrangement
Service Rating
Number of Contacts
Contact Size

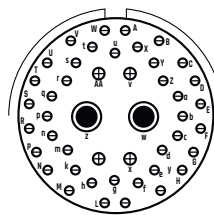

25-46

40 4 2
20 16 8 Coax

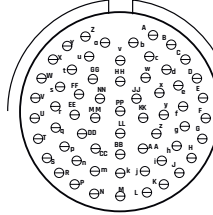

25-61

61
20

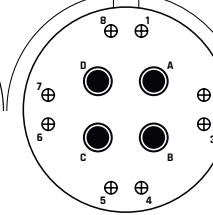

25-62

8 4
16 8

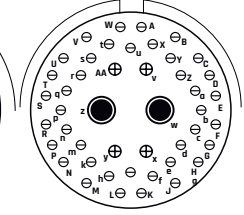

25-90

40 4 2
20 16 8 Twinax

Insert Arrangement
Service Rating
Number of Contacts
Contact Size

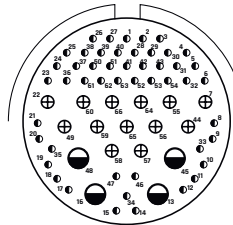

25-F4

Size 22D=M Balance=I
49 13 4
22D 16 12

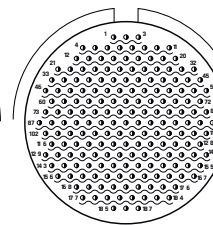

25-187 HD

N
187
23

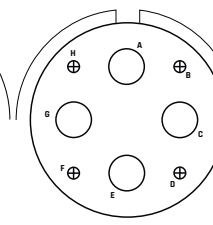

25-1A

N
4 4
16 4

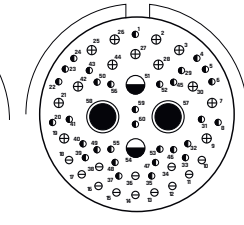

25-AT

N
2 2 13 12 31
10 12 16 20 22D

MIL-DTL-D38999 Series III

BK4S Backshell

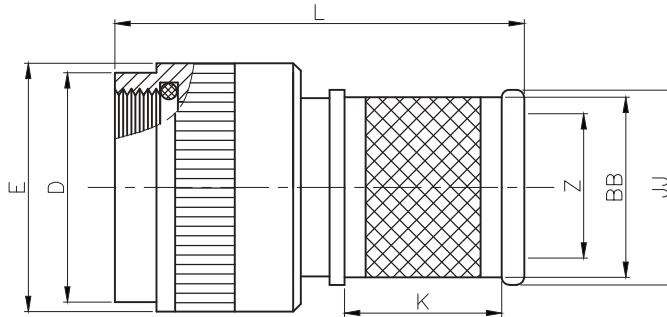

Shell Size Designator	A Thread Class 2B	ØD ± 1.5		ØE +0.20 -0.00		ØZ Cable Max.		ØBB Max.		ØJJ Max.		K Max.		L Max.	
		INCH	MM	INCH	MM	INCH	MM	INCH	MM	INCH	MM	INCH	MM	INCH	MM
8	09/A	0.596	15.14	0.674	17.14	0.281	7.2	0.391	9.9	0.486	12.3	0.433	11.0	1.970	50.0
10	11/B	0.712	18.11	0.791	20.11	0.338	8.6	0.493	12.5	0.587	14.9	0.433	11.0	2.090	53.1
12	13/C	0.829	21.08	0.908	23.08	0.506	12.9	0.665	16.9	0.783	19.9	0.476	12.1	2.100	53.3
14	15/D	0.985	25.04	1.064	27.04	0.562	14.3	0.744	18.9	0.862	21.9	0.476	12.1	2.210	56.1
16	17/E	1.103	28.02	1.181	30.02	0.619	15.7	0.821	20.9	0.939	23.9	0.476	12.1	2.280	57.9
18	19/F	1.220	30.99	1.298	32.99	0.675	17.1	0.891	22.6	1.010	25.6	0.476	12.1	2.360	59.9
20	21/G	1.337	33.96	1.415	35.95	0.731	18.6	0.954	24.2	1.072	27.2	0.476	12.1	2.400	61.0
22	23/H	1.448	36.80	1.527	38.80	0.843	21.4	1.095	27.8	1.213	30.8	0.476	12.1	2.520	64.0
24	25/J	1.566	39.78	1.644	41.78	0.900	22.86	1.160	29.4	1.276	32.4	0.476	12.1	2.520	64.0

BK4R Backshell

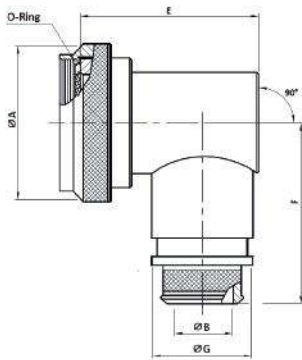

Connector Shell Size/Code	ØA MAX		F MAX		E MAX		ØB +0.010-0.020 (+0.25-0.50)		ØG MAX	
	INCH	MM	INCH	MM	INCH	MM	INCH	MM	INCH	MM
09/A	0.86	21.82	1.279	32.51	0.839	21.33	0.311	7.92	0.591	15.00
11/B	0.99	25.04	1.339	34.03	0.970	24.64	0.374	9.52	0.657	16.70
13/C	1.16	29.36	1.409	35.81	1.090	27.69	0.500	12.70	0.780	19.80
15/D	1.28	32.54	1.469	37.33	1.219	30.98	0.562	14.30	0.843	21.40
17/E	1.41	35.71	1.529	38.86	1.339	34.03	0.625	15.88	0.906	23.00
19/F	1.52	38.51	1.589	40.38	1.409	35.81	0.688	17.50	0.969	24.60
21/G	1.64	41.68	1.659	42.16	1.529	38.86	0.750	19.05	1.031	26.20
23/H	1.77	44.86	1.719	43.68	1.659	42.16	0.875	22.23	1.157	29.40
25/J	1.89	48.03	1.779	45.21	1.779	45.21	0.938	23.83	1.220	31.00

MIL-DTL-38999 Series III

Straight Boot: B1 Style

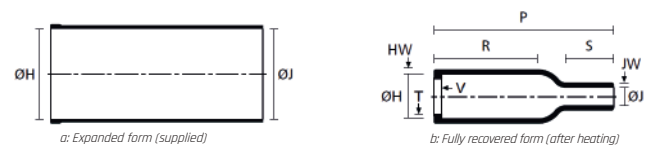
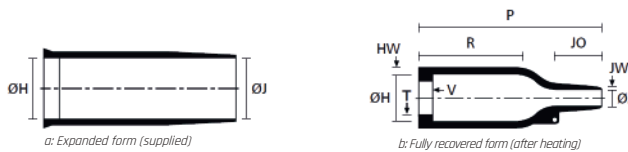

Connector Shell Size	$\varnothing H$ Min. A	$\varnothing H$ Max. B	$\varnothing J$ Min. A	$\varnothing J$ Max. B	$P \pm 10\%$	$R \pm 10\%$	$JO \pm 10\%$	$HW \pm 20\%$	$JW \pm 20\%$	$V \pm 10\%$	$T \pm 20\%$
B=11	24.0 (.94")	10.5 (.41")	24.0 (.94")	6.0 (.23")	38.0 (1.48")	21.0 (.82")	10.0 (.39")	1.6 (.06")	0.5 (.02")	3.0 (.12")	1.0 (.04")
C=13 / D=15	25.0 (.98")	14.0 (.55")	9.0 (.35")	3.5 (.14")	55.0 (2.15")	28.0 (1.09")	16.0 (.62")	1.8 (.07")	0.5 (.02")	3.0 (.12")	1.0 (.04")
E=17 / F=19	31.0 (1.21")	18.0 (.7")	31.0 (1.21")	7.0 (.27")	67.0 (2.61")	35.0 (1.37")	18.0 (.7")	1.8 (.07")	1.0 (.04")	3.0 (.12")	1.0 (.04")
G=21 / H=23	36.0 (1.4")	22.5 (.88")	36.0 (1.4")	8.5 (.33")	80.0 (3.12")	42.0 (1.64")	20.0 (.78")	2.0 (.08")	1.0 (.04")	3.0 (.12")	1.0 (.04")
J=25	43.0 (1.68")	28.0 (1.09")	43.0 (1.68")	10.0 (.39")	79.0 (3.08")	41.0 (1.6")	20.0 (.78")	2.2 (.09")	1.0 (.04")	3.0 (.12")	1.7 (.07")

Connector Shell Size	$\varnothing H$ Min. A	$\varnothing H$ Max. B	$\varnothing J$ Min. A	$\varnothing J$ Max. B	$P \pm 10\%$	$R \pm 10\%$	$HW \pm 20\%$	$JW \pm 20\%$	$V \pm 10\%$	$T \pm 20\%$	S nom.
A=9	16.5 (.64")	7.9 (.31")	16.5 (.64")	3.8 (.15")	25.4 (.99")	14.2 (.55")	1.3 (.05")	1.3 (.05")	3.0 (.12")	1.0 (.04")	6.9 (.27")

Dimensions in mm, inches in brackets. Subject to technical changes.

90 Degree Boot: B2 Style

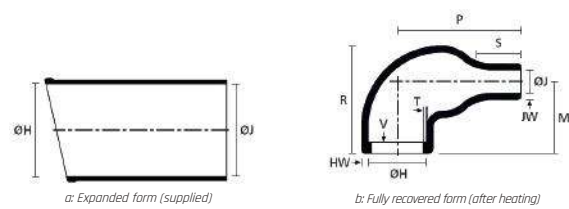
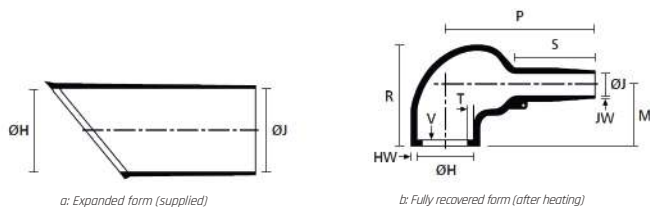

Connector Shell Size	$\varnothing H$ Min. A	$\varnothing H$ Max. B	$\varnothing J$ Min. A	$\varnothing J$ Max. B	$P \pm 10\%$	$R \pm 10\%$	$HW \pm 20\%$	$JW \pm 20\%$	$V \pm 10\%$	$T \pm 20\%$	M Nom.	S Nom.
B=11	24.0 (.94")	10.5 (.41")	24.0 (.94")	6.0 (.23")	26.0 (1.01")	25.0 (.98")	1.3 (.05")	0.5 (.02")	3.0 (.12")	1.0 (.04")	19.0 (.74")	10.0 (.39")
C=13	30.0 (1.17")	15.5 (.6")	30.0 (1.17")	6.0 (.23")	32.0 (1.25")	27.0 (1.05")	1.5 (.06")	0.8 (.03")	3.0 (.12")	1.0 (.04")	19.0 (.74")	12.0 (.47")
D=15	31.0 (1.21")	18.0 (.7")	31.0 (1.21")	7.0 (.27")	40.0 (1.56")	31.0 (1.21")	1.8 (.07")	1.0 (.04")	3.0 (.12")	1.0 (.04")	21.0 (.82")	15.0 (.59")
E=17	36.0 (1.4")	22.5 (.88")	36.0 (1.4")	8.5 (.33")	46.0 (1.79")	38.0 (1.48")	1.8 (.07")	1.0 (.04")	3.0 (.12")	1.0 (.04")	26.0 (1.01")	15.0 (.59")
F=19	43.0 (1.68")	28.5 (1.11")	43.0 (1.68")	10.0 (.39")	55.0 (2.15")	45.0 (1.76")	2.0 (.08")	1.0 (.04")	3.0 (.12")	1.7 (.07")	30.0 (1.17")	16.0 (.62")

Connector Shell Size	$\varnothing H$ Min. A	$\varnothing H$ Max. B	$\varnothing J$ Min. A	$\varnothing J$ Max. B	$P \pm 10\%$	$R \pm 10\%$	$HW \pm 20\%$	M Nom.	$JW \pm 20\%$	$V \pm 10\%$	$T \pm 20\%$	S Nom.
A=9	16.5 (.64")	7.9 (.31")	16.5 (.64")	2.5 (.1")	18.3 (.71")	20.1 (.78")	1.0 (.04")	15.2 (.59")	1.6 (.06")	3.3 (.13")	1.0 (.04")	5.1 (.2")

Material Specifications:

Material Description: Fluid resistant elastomer
 Minimum Shrink Temperature: +275°F (+135°C)
 Operating Temperature Range: -103°F to +302°F
 (-75°C to +150°C)

Adhesive Specifications:

Adhesive: High performance, pre-coat, 1 part epoxy
 Operating Temperature: -103°F to +392°F
 (-75°C to +200°C)

Solvent Resistance

De-icing Fluid: Excellent
 Petrol: Excellent
 Lubricating Oil: Excellent
 Hydraulic Oil: Excellent

Dimensions in mm, inches in brackets. Subject to technical changes.

MIL-DTL-38999 Series III

Dust Cap

Dust Cap Drawing For Plug Connectors

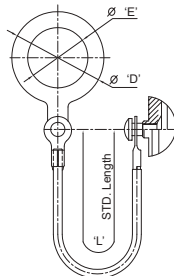

S.S. Rope with Ring
Teflon Coating

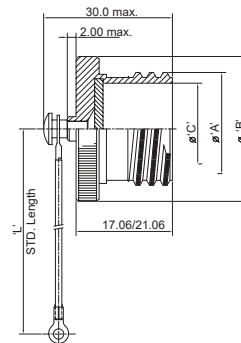

Shell Size	"A" Thread	B Max	C (+0.0 -0.15)	D Max	E Min	L + 13.0 -7.0
09/A	0.625"	23.0	12.50	24.0	13.0	127
11/B	0.750"	26.0	15.75	27.0	18.0	
13/C	0.875"	31.0	19.53	30.0	20.0	
15/D	1.000"	33.0	22.71	31.0	23.0	
17/E	1.1875"	37.0	25.88	37.0	26.0	
19/F	1.250"	40.0	28.55	40.0	29.0	
21/G	1.375"	44.0	31.72	44.0	32.0	
23/H	1.500"	46.0	34.80	45.0	34.0	
25/J	1.625"	50.0	38.07	49.0	39.0	

All Dimensions are in mm

Dust Cap Drawing For Jam Nut Receptacle Connectors

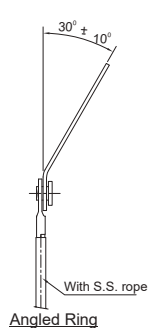

Angled Ring

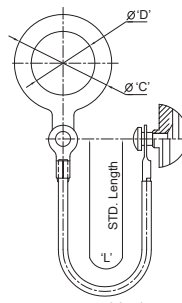

S.S. Rope with Ring
Teflon Coating

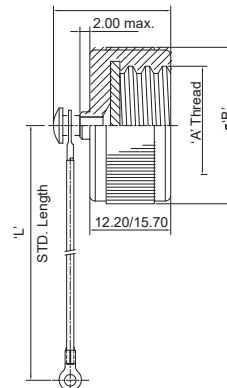

Shell Size	"A" Thread	B Max	C Max	D Min	L + 13.0 -7.0
09/A	0.625"	23.0	27.0	17.64	127
11/B	0.750"	28.0	32.0	21.97	
13/C	0.875"	31.0	37.0	25.15	
15/D	1.000"	32.0	40.0	29.92	
17/E	1.1875"	37.0	44.0	32.0	
19/F	1.250"	39.0	46.0	36.27	
21/G	1.375"	42.0	49.0	38.25	
23/H	1.500"	45.0	54.0	42.62	
25/J	1.625"	49.0	56.0	44.45	

All Dimensions are in mm

MIL-DTL-D38999 Series III

Dustcap

Dust Cap Drawing For Square Flange Receptacle Connectors

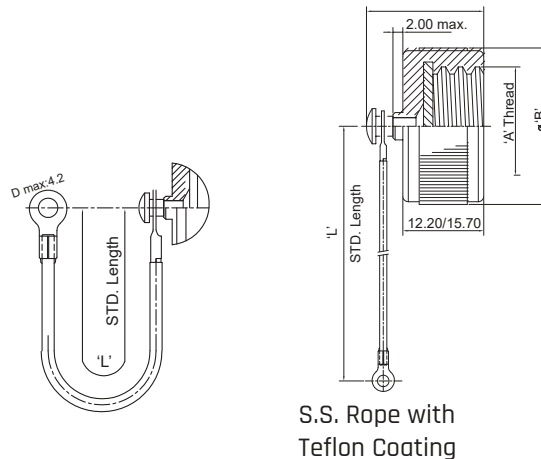

Shell Size	"A" Thread	B Max	L + 13.0 -7.0
09/A	0.625"	23.0	127
11/B	0.750"	28.0	
13/C	0.875"	31.0	
15/D	1.000"	32.0	
17/E	1.1875"	37.0	
19/F	1.250"	39.0	
21/G	1.375"	42.0	
23/H	1.500"	45.0	
25/J	1.625"	49.0	

Conductive Gaskets

Electrical Properties

Contents	Properties
Material	Nickel Coated Graphite
Temp. Rating	-75°C // +150°C
Volume Resistivity	Max. 0.10
Specific Gravity (at 25°C)	2.0±0.3
Hardness (Shore A)	60±5
Tensile Strength (kgf/cm ²)	Min. 20
Tear Strength (kN/m)	Min. 6
Elongation(%)	Min. 200

MIL-DTL-D38999 Series III Conductive Gasket Drawing Square Flange Receptacle

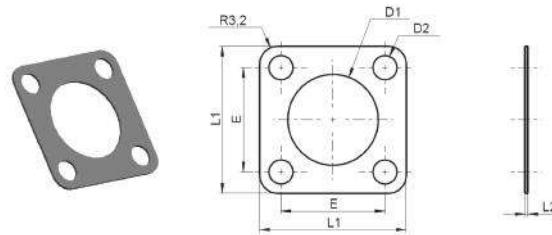

Size	D1 (+0.4)	D2 (-0.3)	L1 (± 0.25)	L2 (± 0.1)	E (± 0.25)
A=9	15.88	3.50	23.83	0.51	18.26
B=11	19.05		26.19		20.65
C=13	22.23		28.56		23.01
D=15	25.40		30.96		24.61
E=17	30.16		34.80		27.00
F=19	31.75		36.53		29.36
G=21	34.93		39.70		31.75
H=23	38.10	4.50	42.88	34.93	
J=25	41.50		46.50	37.10	

Jam Nut Receptacle

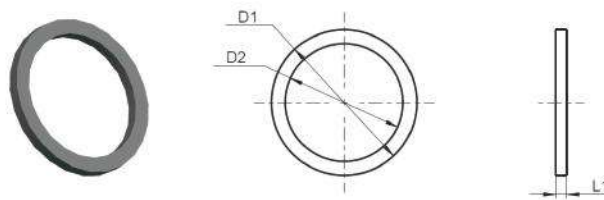

Size	D1	D2	L1 (+0.1/-0.15)
A=9	24.00	20.00	2.00
B=11	29.00	25.00	
C=13	32.00	28.00	
D=15	35.00	31.00	
E=17	38.50	34.50	
F=19	43.00	37.00	
G=21	46.00	40.00	
H=23	50.00	44.00	
J=25	53.00	47.00	

MIL-DTL-D38999 Series III

Crimp Contacts

Contact Size	Pins	Sockets	Cable Type
12	M39029/58-365	M39029/56-353	
16	M39029/58-364	M39029/56-352	
20	M39029/58-363	M39029/56-351	
22D	M39029/58-360	M39029/56-348	
8(Coax)	M39029/60-367	M39029/59-366	M17/95-RG180
8(Twinax)	M39029/90-529	M39029/91-530	M17/176-00002
12 (Coax)	M39029/28-211	M39029/75-416	M17/94-RG179 M17/113-RG316 M17/119-RG174
	M39029/28-409	M39029/75-417	M17/95-RG180 Raychem 9528 A1318
16 (Coax)	M39029/76-424	M39029/77-428	M17/94-RG179 M17/113-RG316 M17/119-RG174 KX22A
	M39029/76-425	M39029/77-429	M17/93-RG178 M17/169-00001

*For power and high speed contacts, please consult us.

Sealing Plugs

Contact Size	Part Number
12	MS27488-12-2
16	MS27488-16-2
20	MS27488-20-2
22D	MS27488-22-2
23	MS27488-22-2

MIL-DTL-D38999 Series III

Tools

Crimp Tools



Contact Size	Contact Type	Crimping Tool	Positioner
8(Coax)	Inner Pin &Socket	M22520/2-01	M22520/2-31
	Outer Pin &Socket	M22520/5-01	M22520/5-41
12(Coax)	Inner Pin &Socket	M22520/2-01	M22520/2-34
	Outer Pin &Socket	M22520/31-01	M22520/31-02
12	Pin	M22520/1-01	M22520/1-04
	Socket	M22520/1-01	M22520/1-04
16(Coax)	Inner Pin &Socket	M22520/2-01	M22520/2-35
	Outer Pin &Socket	M22520/4-01	M22520/4-02
16	Pin	M22520/1-01	M22520/1-04
	Socket	M22520/1-01	M22520/1-04
20	Pin	M22520/1-01	M22520/1-04
	Pin	M22520/2-01	M22520/2-10
	Socket	M22520/1-01	M22520/1-04
	Socket	M22520/2-01	M22520/2-10
22D	Pin	M22520/2-01	M22520/2-09
	Socket	M22520/2-01	M22520/2-07
23	Pin	M22520/2-01	M22520/2-13
	Socket	M22520/2-01	M22520/2-16

Insertion and Removal Tools

Plastic Tools



Contact Size	Insertion Tool	Removal Tool	Colour	
			Insertion	Extraction
8 Power/Coax	*	M81969/14-12	-	green
12	M81969/14-04	M81969/14-04	yellow	white
16	M81969/14-03	M81969/14-03	blue	white
20	M81969/14-10	M81969/14-10	red	orange
22D	M81969/14-01	M81969/14-01	green	white

*Manual Insertion

Metallic Tools



Contact Size	Straight Type		Angle Type	
	Insertion Tools	Removal Tools	Insertion Tools	Removal Tools
8 Power/Coax	-	809 961	-	809 845
12	-	-	809 838	809 839
16	809 816	809 846	809 812	809 820
20	809 817	809 847	809 813	809 821
22D	809 819	809 849	809 815	809 823

MIL-DTL-D38999 Series III

Other Backshell Types

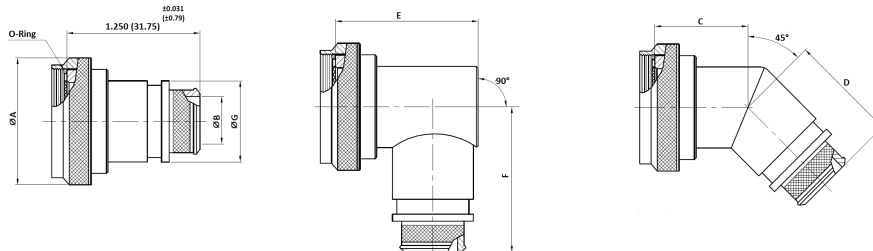

All dimensions are in INCHES (mm)

Part Numbering System

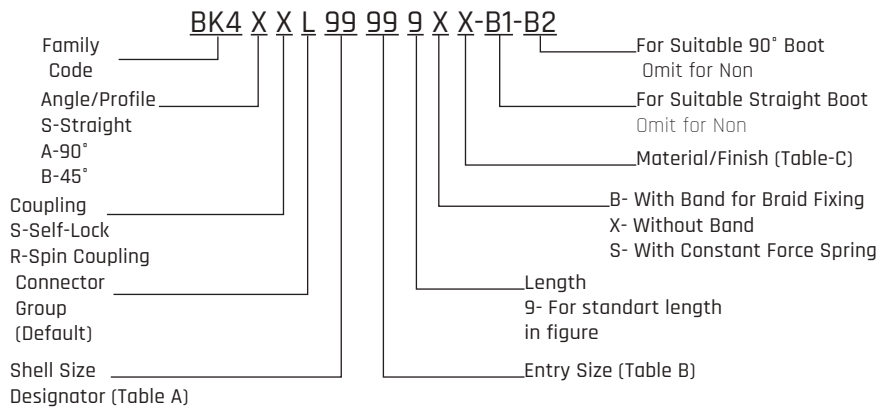

Table B

Entry Size	ØB +0.010-0.020 (+0.25-0.50)		ØG MAX	
	INCH	MM	INCH	MM
02	0.124	3.17	0.208	9.80
03	0.187	4.75	0.528	13.40
04	0.250	6.35	0.547	13.90
05	0.311	7.92	0.591	15.00
06	0.374	9.52	0.657	16.70
07	0.437	11.12	0.717	18.20
08	0.500	12.70	0.780	19.80
09	0.562	14.30	0.843	21.40
10	0.625	15.88	0.906	23.00
11	0.688	17.50	0.969	24.60
12	0.750	19.05	1.031	26.20
13	0.812	20.65	1.094	27.80
14	0.875	22.23	1.157	29.40
15	0.938	23.83	1.220	31.00
16	1.000	25.40	1.283	32.60
17	1.082	27.50	1.346	34.20
18	1.125	28.58	1.409	35.80
19	1.208	30.70	1.472	37.40
20	1.250	31.75	1.535	39.00
21	1.333	33.88	1.598	40.60
22	1.374	34.92	1.661	42.20
23	1.440	36.58	1.744	44.29
24	1.500	38.10	1.787	45.40

Table A

Shell Size Designator	MAX. Entry Size (Normal Style)	Connector Shell Size/Code	ØA MAX		C MAX		D MAX		F MAX		E MAX	
			INCH	MM	INCH	MM	INCH	MM	INCH	MM	INCH	MM
08	04	09/A	0.86	21.82	0.519	13.20	1.150	29.21	1.279	32.51	0.839	21.33
10	06	11/B	0.99	25.04	0.540	13.72	1.170	29.72	1.339	34.03	0.970	24.64
12	08	13/C	1.16	29.36	0.570	14.48	1.200	30.50	1.409	35.81	1.090	27.69
14	10	15/D	1.28	32.54	0.590	14.99	1.230	31.25	1.469	37.33	1.219	30.98
16	12	17/E	1.41	35.71	0.620	15.75	1.250	31.75	1.529	38.86	1.339	34.03
18	14	19/F	1.52	38.51	0.629	16.00	1.259	32.00	1.589	40.38	1.409	35.81
20	15	21/G	1.64	41.68	0.659	16.76	1.289	32.76	1.659	42.16	1.529	38.86
22	17	23/H	1.77	44.86	0.681	17.30	1.320	33.53	1.719	43.68	1.659	42.16
24	20	25/J	1.89	48.03	0.708	18.00	1.339	34.03	1.779	45.21	1.779	45.21

All dimensions are in INCHES (mm)

Table C

Code	Material/Finish
N	Aluminium Alloy/ Electroless Nickel
W	Aluminium Alloy/ Cadmium Olive Drab Over Electroless Nickel
Y	Aluminium Alloy/ Zinc-Cobalt Dark Olive Drab Over Electroless Nickel
TN	Aluminium Alloy/ Nickel Teflon
ZN	Aluminium Alloy/ Zinc Nickel
S	Stainless Steel/ Passivate
K	Nickel Aluminium Bronze/ Shot Blast
P	Aluminium Alloy/ Cadmium Olive Drab Over Electroless Nickel(Selective Plating)

Note: When maximum cable entry exceeds consult MATEC Electronics.



MATEC Electronics is an authorized and leading distributor, that specializes on the design and custom-engineered connectors, cables and electronic interconnect solutions for Military-Aerospace, Industry and Telecom market fields. MATEC's deep technical and commercial knowledge on it's concentrated product portfolio has made the company the chosen distributor of the customers in the region it serves Turkey, Middle East, Africa, Eastern Europe.

MATEC Electronics mainly distributes world's leading interconnect manufacturers, Amphenol, HellermannTyton, Reflex Photonics and Rennsteig. The company provides not only sales channel for these manufacturers, but also give services to it's valuable customers with highly experienced field application engineers and inside customer services.

Head Office

Ahi Evran Cad. No: 21
Kat: 4 Daire: 24
Polaris Plaza Maslak,
Sariyer, ISTANBUL
+90 212 346 16 02

Branch Office

Prof. Dr. Ahmet
Taner Kışlalı Mahallesi
2879. Sokak No:14
Cankaya, ANKARA
+90 312 240 04 14

www.matecelectronics.com
sales@matecelectronics.com